

# DOLPHIN

Portable Automatic Key Cutting Machine  
XP-005

## User Manual

V1.0

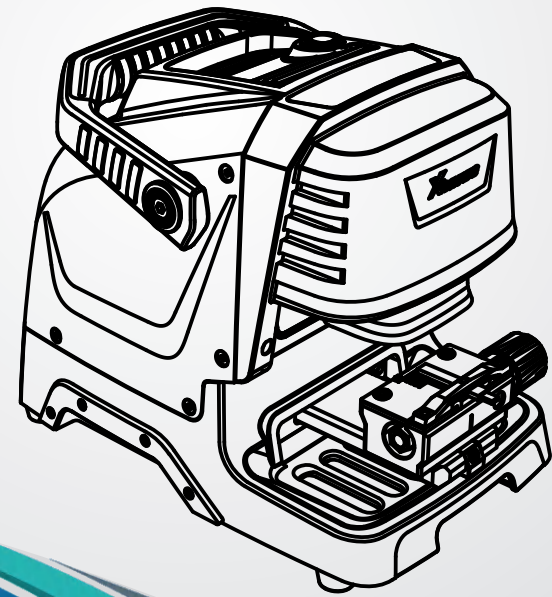

*Xhorse*<sup>®</sup>



**XP-005**

Portable automatic key cutting machine

## TABLE OF CONTENTS

1 Safety precautions and warnings .....	02
2 General information	
2.1 Machine description .....	03
2.2 Machine characteristics .....	03
3 Product packaging checklist .....	04
4 Overview	
4.1 Structure diagram .....	06
4.2 Specification .....	07
4.3 Software overview .....	09
4.3.1 Introduction .....	09
4.3.2 Smart phone operation system .....	09
4.3.3 Software update .....	09
5 Installation instruction	
5.1 Cutter and probe installation .....	10
5.2 Cutter and probe uninstallation .....	11
5.3 Clamp installation .....	12
5.4 Pictures of clamps .....	13
5.5 Clamp M2 sides guide .....	14
5.6 Clamp M4 description .....	15
6 Operation instructions on APP	
6.1 Height level adjustment .....	16
6.2 Clamp calibration .....	19
6.3 Cutting calibration .....	22
6.4 How to use the key database .....	24
6.5 How use key duplication .....	27
6.6 How to use cut by bitting .....	30
6.7 How to use find bitting .....	34
7 Online update	
7.1 Database online update .....	36
7.2 Update by upgrade kit .....	38
8 Maintenance .....	41
9 Warranty and after-sale description .....	41

## 1. Safety precautions and warnings

To avoid injuries to operators and damages to machines, please read this product user manual carefully before you start and follow the safety notes listed below:

- Always use the machine under safe environment
- Wear protective goggles that are in line with ANSI standard
- Put down the protective shield when the machines is working
- Do not have clothes, hair, hands and other tools close to the machine when it is working
- Do not leave the machine unattended when it is working
- Do not use a damaged or loose socket
- Unplug the machine when it is not in use for a long time
- Do not place the machine in a place that is damp, greasy and dusty
- Do not put things like tool or containers on the machine
- Put the machine on a flat and firm surface
- Keep the machine dry and clean
- Unplug the machine instantly under unusual circumstance

## 2. General information

### 2.1 Machine description

Dear customers, thank you for choosing XP-005 portable automatic key cutting machine. Dolphin XP-005 is a portable machine, with a small volume and light weight, is particularly and carefully designed for locksmiths worldwide.

This product user manual provides operating instructions for you to use the machine correctly and safely. To avoid injuries and financial loss, please carefully read this manual through before you start to operate the machine. And we kindly remind you to keep this manual properly for future reference.

All the information and illustrations in this document are for guidance only. Xhorse Electronics reserves the right to alter products designs, dimensions or info to improve the products quality. The contents of this document are fully protected by Copyright and may not be copied or reproduced in any form (e.g. mechanical, electronic, printing or video recording), without written permission from Xhorse Electronics.











### 2.2 Machine characteristics









- Smart control and operation on APP and build-in database
- Portability and build-in Lithium battery with a long battery life
- Support clamps M1(standard equipped) /M2(standard equipped) /M3(optional)/M4(optional)
- Supporting sided/track/dimple keys/tibbe keys/some household keys
- Cutter and probe work in parallel
- Aluminum structure
- Imported ball screw with high precision
- Cross rail with high rigidity
- Supporting online update
- Operating in multiple languages

Note : \*Lithium battery is an optional accessory

### 3. Product packaging checklist

A full package of XP-005 should include accessories listed in the following table. Please check when you get this product and contact your distributor if anything in the table is missing.

Name	Sample picture	Quantity	Description
Machine		1	Key cutting machine
2.5mm cutter		1	Cutting tool ( $\phi 2.5 * \phi 6 * 40L$ )
1.5mm cutter		1	Cutting tool ( $\phi 2.5 * \phi 6 * 40L$ )
Probe		2	Probing tool ( $\phi 1.5 * \phi 6 * 45L$ )
2 mm hexagon bar wrench		1	Tracer point tool, key fixation on clamp M1
4 mm hexagon bar wrench		1	Clamp installation tool
Power adapter		1	Power supply
1.5m Power cord of Mainland China standard		1	Connect to power
1.5m Power cord of UK standard (optional)		1	Connect to power
1.5m Power cord of US standard (optional)		1	Connect to power
1.5m Power cord of EU standard (optional)		1	Connect to power

Built-in battery (optional)		1	Portable power supply
Brush		1	Cleaning tool
Clamp M1 and link stopper		1	For single/double sided keys
Clamp M2 and shim		1	For internal/external track keys
Clamp M3 (optional)		1	FO21/SX9 key clamp
Clamp M4 (optional)		1	Household key clamp
Product quality certificate		1	Factory inspection report and packing list
User manual		1	Machine assembly/adjustment/operation instruction

## 4. Overview

### 4.1 Structure diagram



### 4.2 Specification

Input voltage	90-264V AC
Input frequency	47-63Hz
Power	150W
Power parameter	24V DC /6.67A
Battery capacity	63Wh
Principal axis rotation speed	12000rpm
Motor Torque	0.15N.m
Working temperature	0-50°C(-4-158°F)
Humidity	10-90%
Net weight	15kg
Gross weight	18kg
Machine size	315mm*218mm*270mm
Package size	510mm*315mm*345mm



Machine size

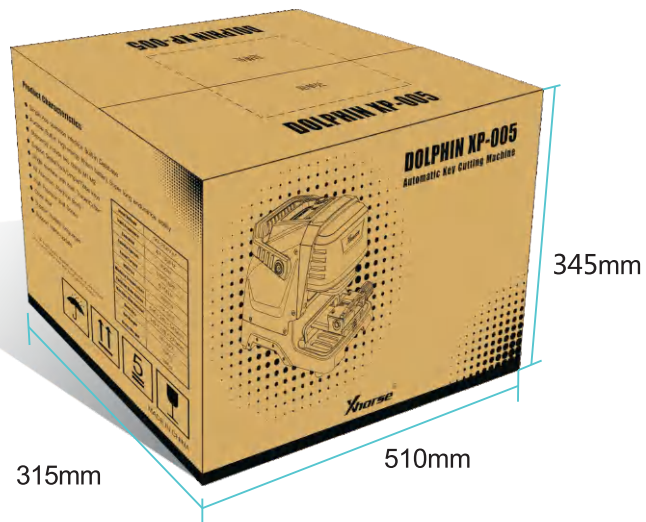

Package size

## 4.3 Software overview

### 4.3.1 Introduction

- Supporting self-calibration
- Supporting key duplication and cutting for vehicle keys
- Supporting universal key decode for multiple key types
- Operation on APP through Bluetooth
- Build-in key database

### 4.3.2 Smart phone operation system

- Android : Android 4.0 and above version
- Apple devices: IOS 8.0 and above version

### 4.3.3 Software update

- Online update on APP
- Update through Xhorse ' Upgrade Kit '

## 5. Installation instruction

### 5.1 Cutter and probe installation

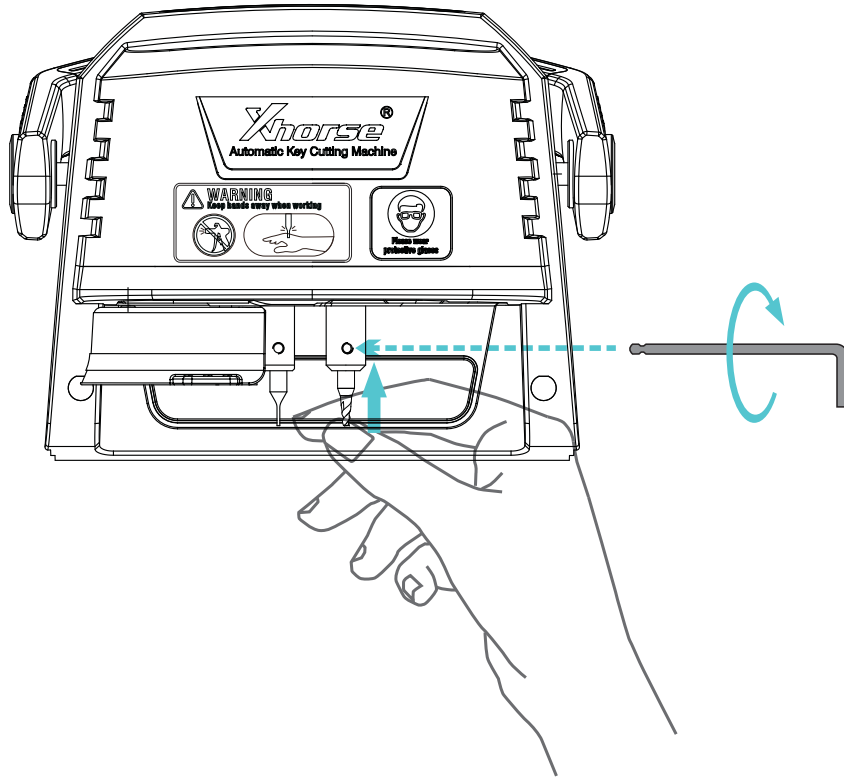

#### Installation steps:

- 1) Put the cutter into the cutter mounting hole and push the cutter to the limit. Then drop the cutter 2-5 mm down. When the screw is perpendicular to the notched part of the side of the milling cutter, the locking screw and the fixed milling cutter.
- 2) Push the probe into the probe mounting hole and the tip of probe need to be higher than the tip of cutter. Turn the 'probe locking screw' clockwise until the probe is locked.

### 5.2 Cutter and probe uninstallation

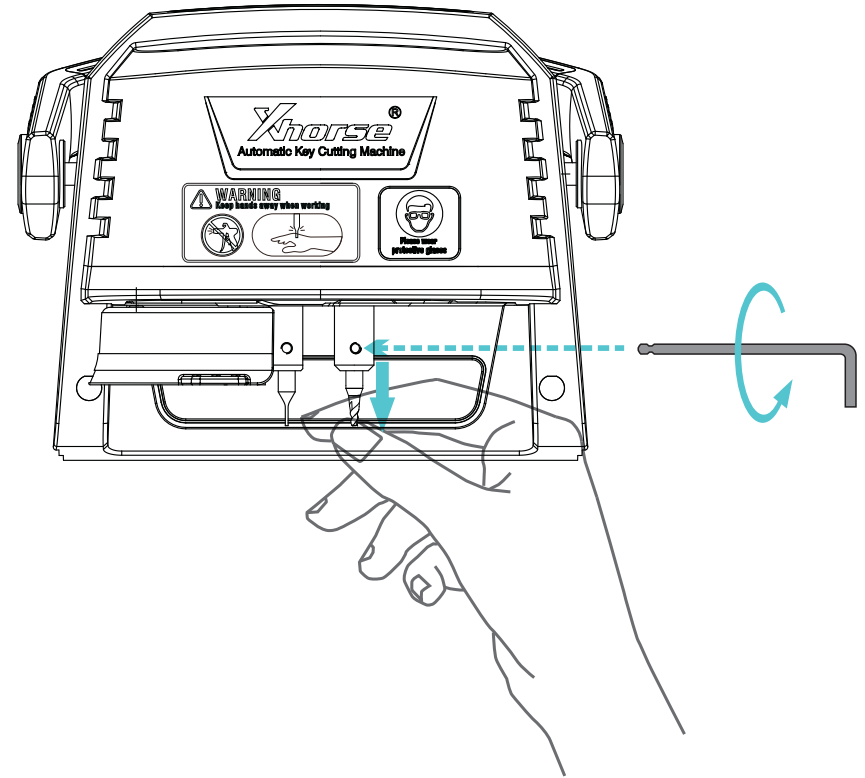

#### Uninstallation steps:

- 1) Unscrew the locks for cutter and probe counter-clockwise until they are loosened off.
- 2) Take the cutter or probe off when it is loose.

### 5.3 Clamp installation

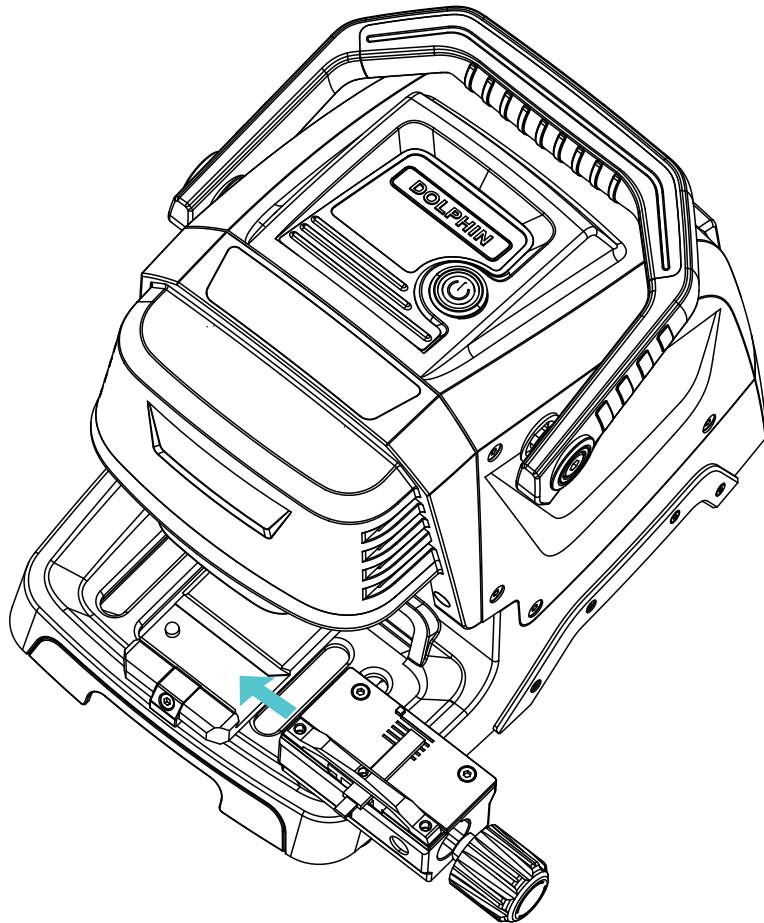

Installation steps:

- 1) Unscrew the clamp locking screw .
- 2) Choose the proper clamp for your keys, slide it in to the clamp holder and push it to the limit from right side.
- 3) Fix the clamp locking screw until the clamp is locked.

### 5.4 Pictures of clamps



Clamp M1

Supporting type (as picture below)

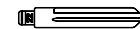

Standard single/double sided key



Clamp M2

Supporting type (as picture below)

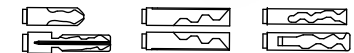

4 Track external    2 Track external    4 Track internal



Channel track    Dimple keys



Clamp M3

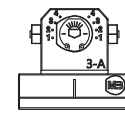

Support type (FO21 example)

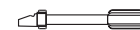

FO21

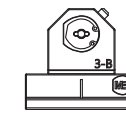

Support type (SX9 example)



SX9



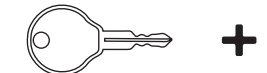

Clamp M4

Supporting type (as picture below)



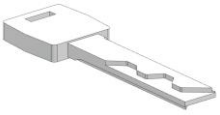
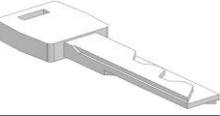
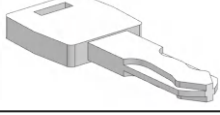
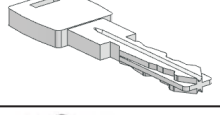
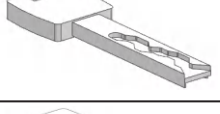
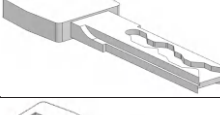
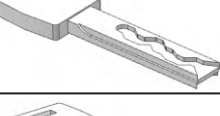
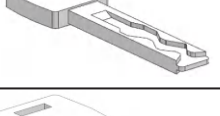

### 5.5 Clamp M2 sides selection

Key types	Cutting side pictures	Clamp cutting sides	Description
2 Track external		A/C	1) A side and D side work for the same types of keys, please select it according to the deepness of the keys  2) Dimple keys need a specialized cutter
		A/B	
4 Track external		A/D	
		A/D	
Channel track		A/D	
		A/C	
		A/B	
4 Track internal		A/D	
Dimple keys		A/D	

### 5.6 Clamp M4 instruction



Clamp M4 for household keys, mainly support standard single and double sided keys, also for crucifix keys, example as follows:

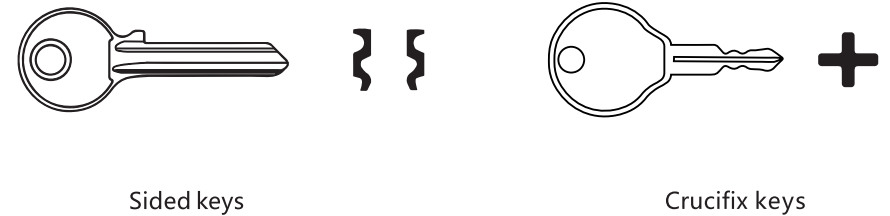

## 6. Operation instructions on APP

The system needs to initialize for first use. The steps as follows:

### 6.1 Height level adjustment

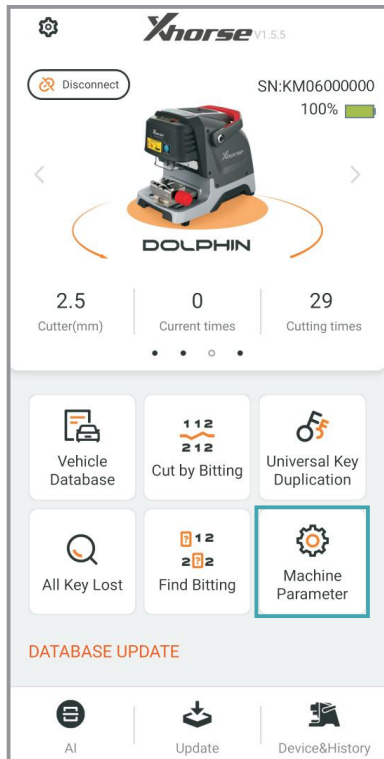

1) Enter Dolphin XP-005 operation main interface and click on 'Machine Parameter'.

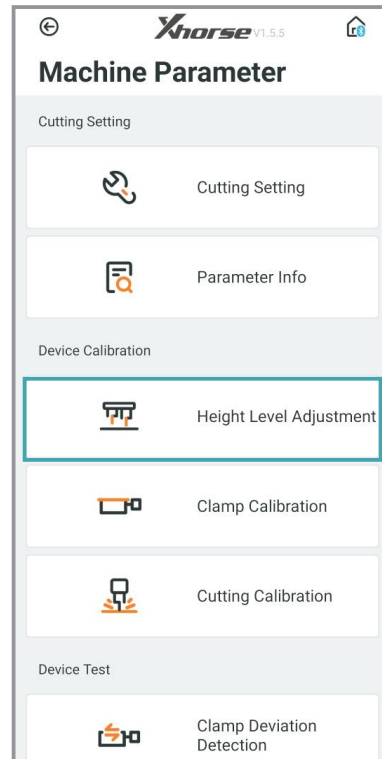

2) Click on 'Height Level Adjustment'.

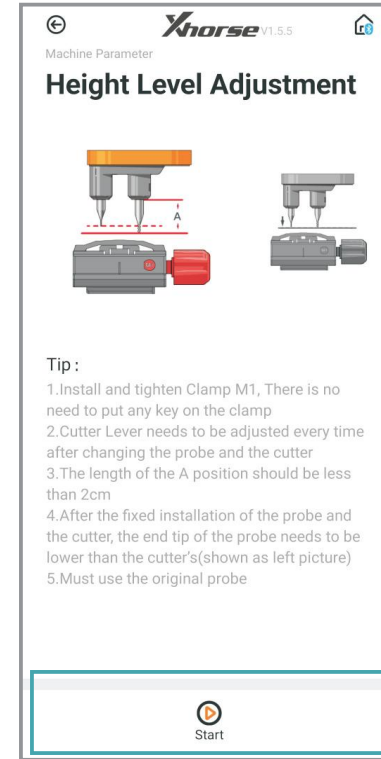

3) Adjust the heights of cutter and probe by following the tips on the screen, then click on 'Start'.

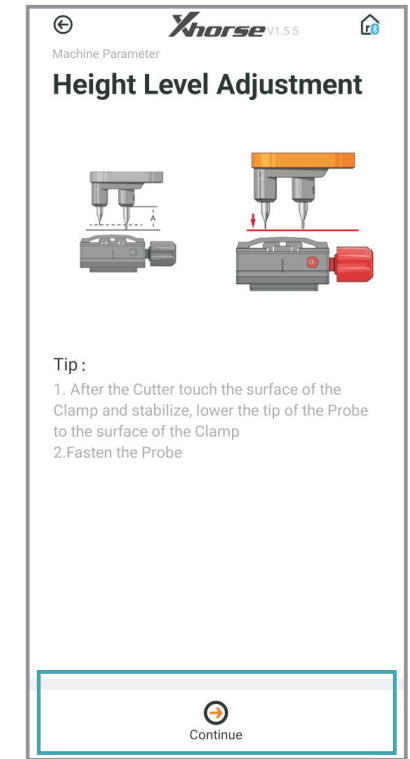

4) After the machine has stopped, adjust the points of probe and cutter to the same level by following the tips on the screen. Then click on 'Continue'.

## 6. 2 Clamp calibration

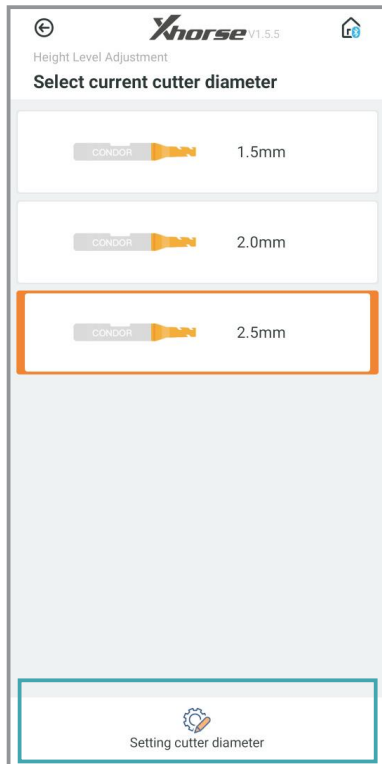

5) After the machine has stopped, select the diameter of the installed cutter, click on 'Setting cutter diameter' for finish height level adjustment.

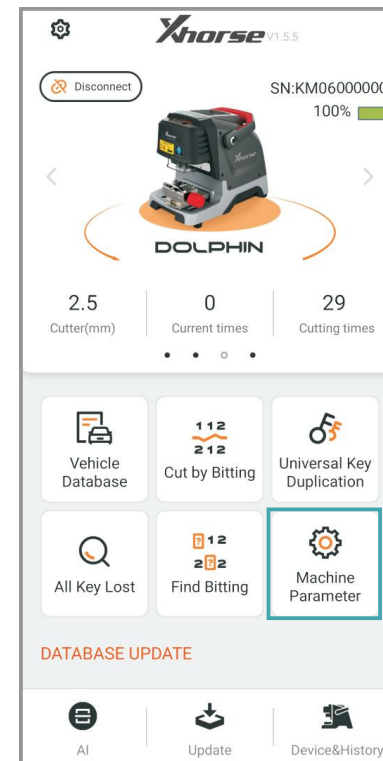

1) Enter Dolphin XP-005 operation main interface, click on 'Machine Parameter'.

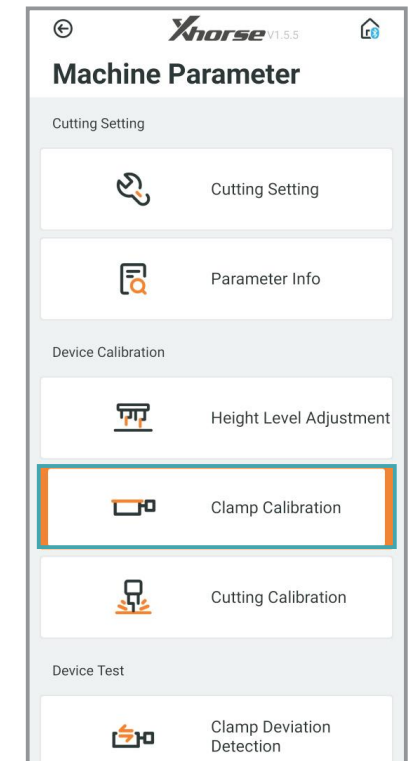

2) Click on 'Clamp Calibration'.

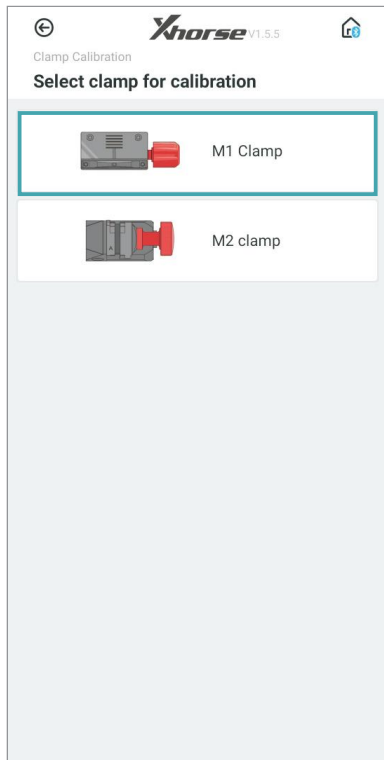

3) Select clamp M1.

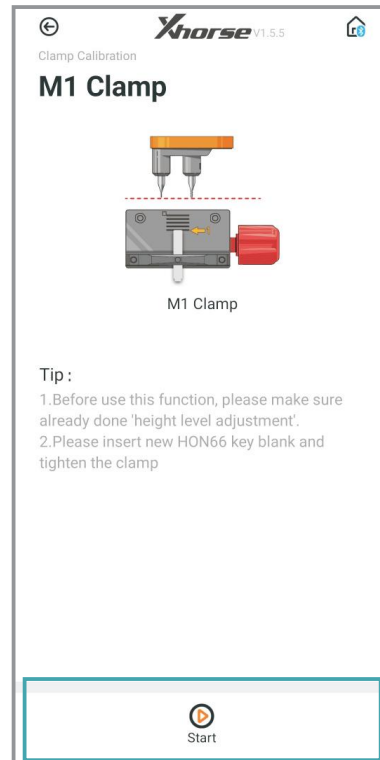

4) Following the tips on the screen, put HON66 key blank, click on 'Start' and wait until it is finished.

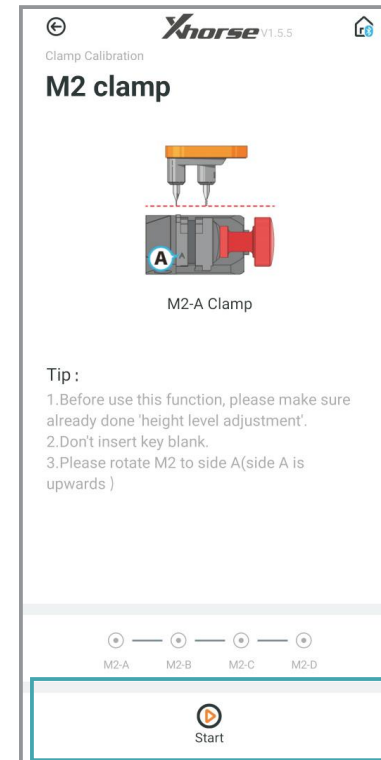

5) Select clamp M2, select the side A and do not place any key on the clamp, click on 'Start'.

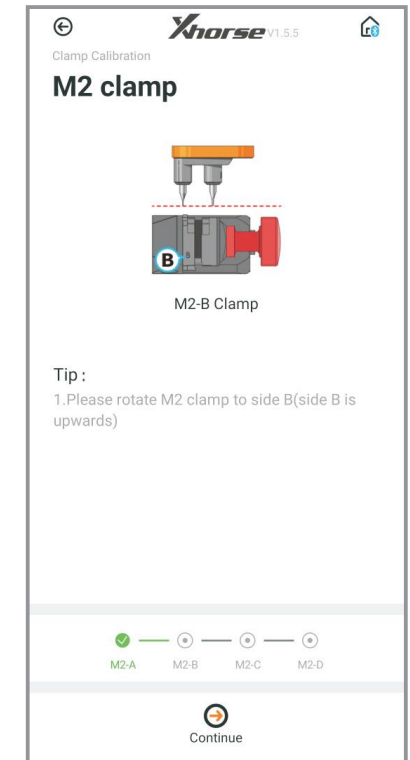

6) Follow the tips on the screen and change to other B, C, D sides for finish calibration.

## 6.3 Cutting calibration

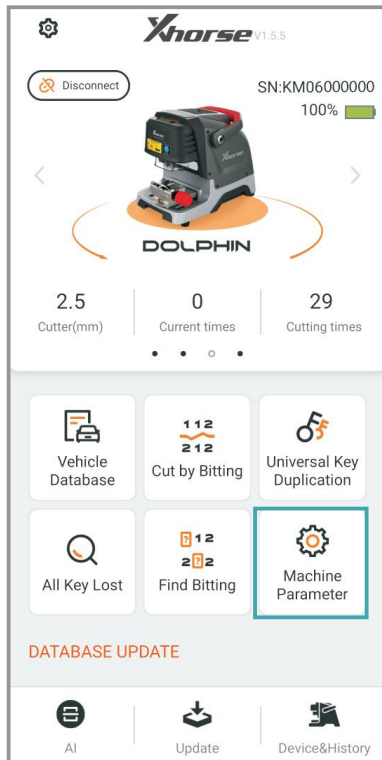

1) Enter the operation main interface and click on 'Machine Parameter'.

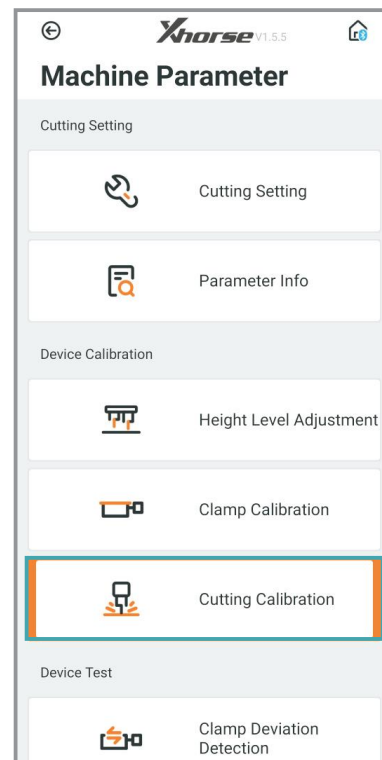

2) Click on 'Cutting Calibration'.

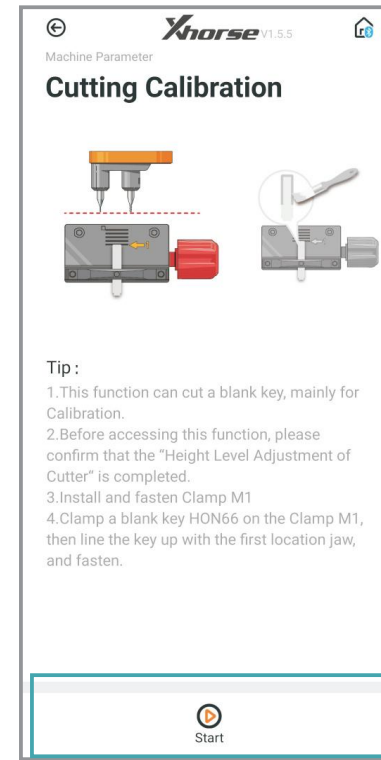

3) Operate by following the tips and click on 'Start'.

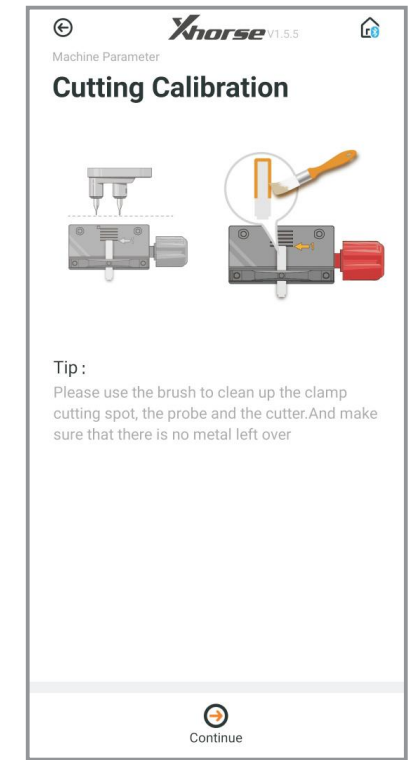

4) Clean the cutter, probe and working area with a brush. Click on 'Continue' for finish cutting calibration.

## 6.4 How to use the key database.

Three ways to make keys from the key database

1. Original key code card from factory
2. Key code information on lock for some car models
3. Other ways to get the key code

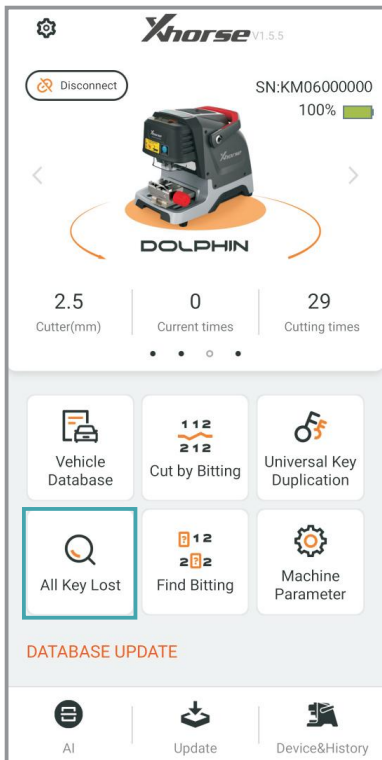

1) Click on 'All Key Lost'.

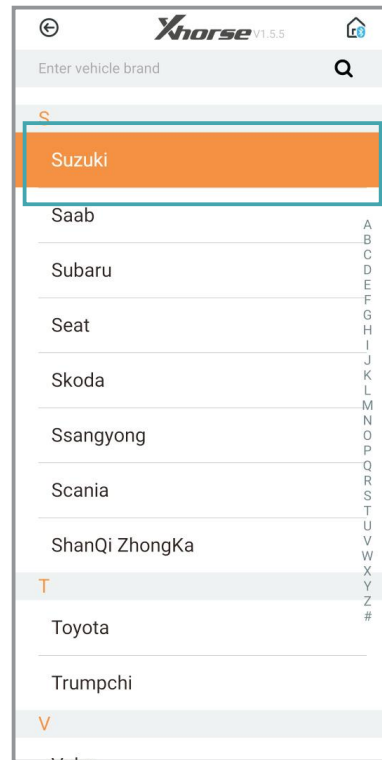

2) Select a car maker.



3) Put in the key code circled and click 'QUERY'.

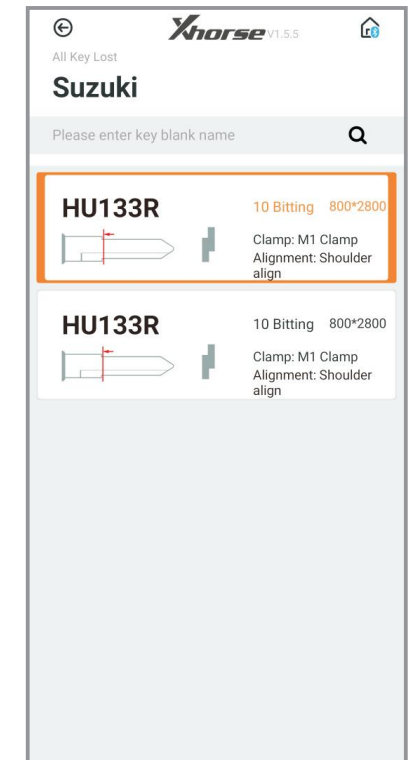

4) Select the key series .

## 6.5 How to use key duplication

Car models and years are needed for key duplication

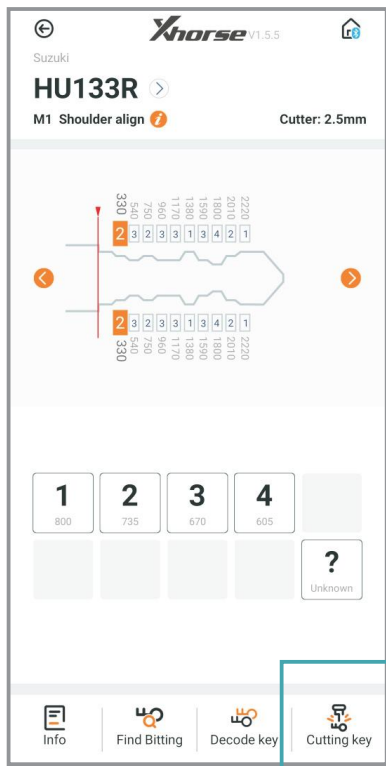

5) The key bit will be automatically generated on the screen, click 'Cutting Key'.

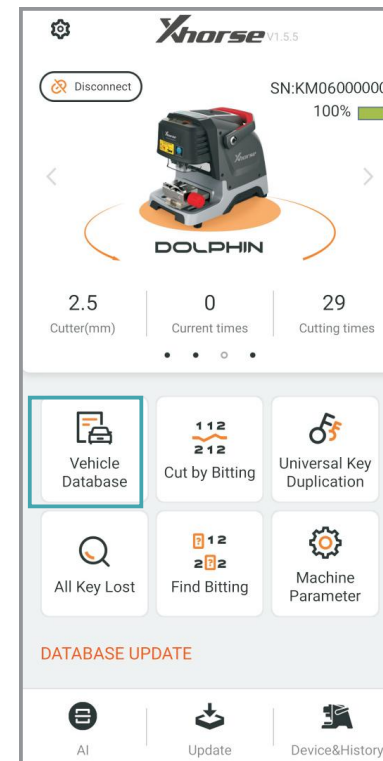

1) Click on 'Vehicle Database' on the main page.

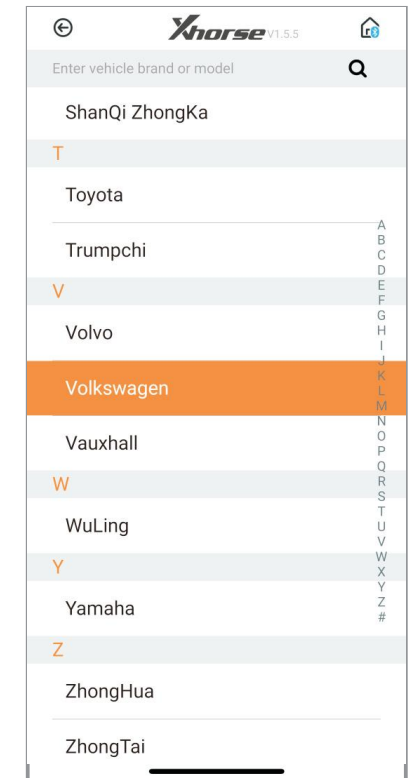

2) Select or type the car maker .

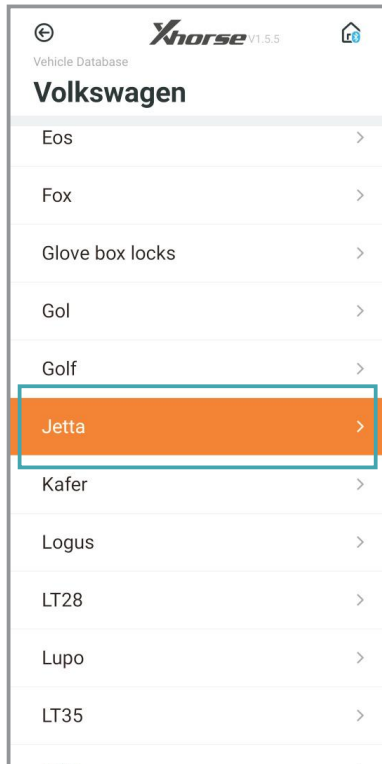

3) Select the car model.

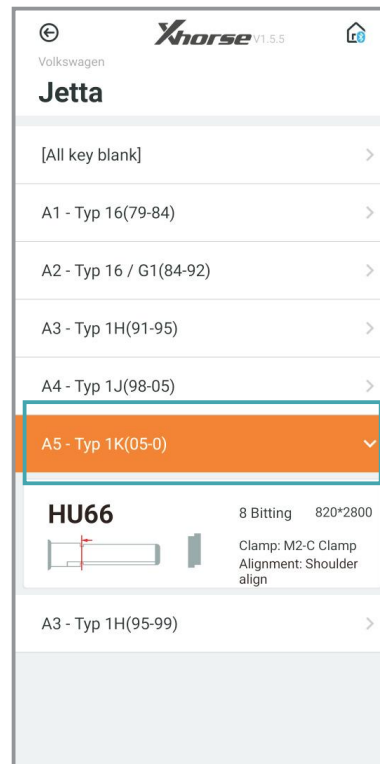

4) Select the car model and year.

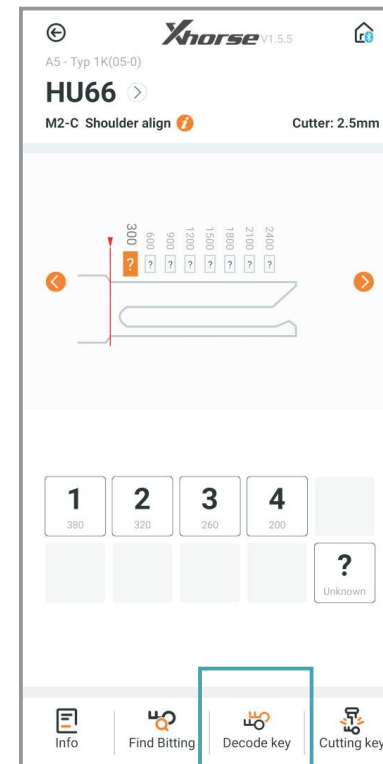

5) Follow the tips on screen and correctly put the key on the clamp, click 'Decode Key'.

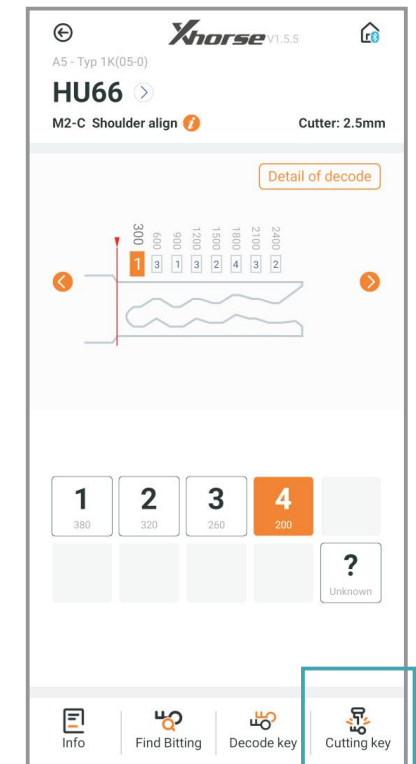

6) After getting the original key bit, put a new blank key and click on 'Cutting Key'.



### 6.6 How to use cut by bitting

Two ways of using the key bitting to make a key:

Method 1 :

Making a key without the original key.

1. Use some special tool to get the key bitting.
2. Break down the lock to read the key bitting on each metal of lock.

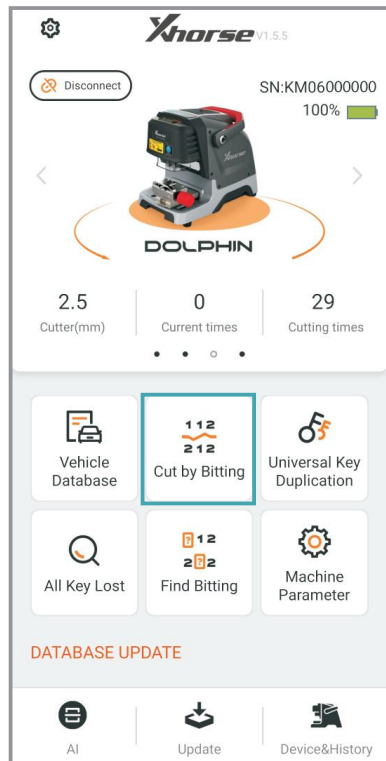

1) Click on 'Cut by Bitting'.

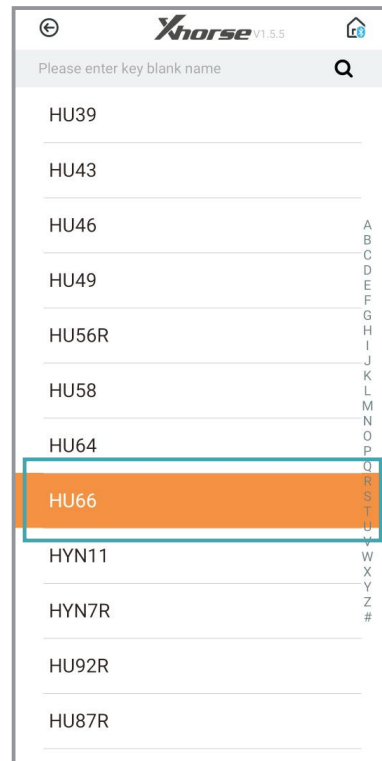

2) Select a key blank type.

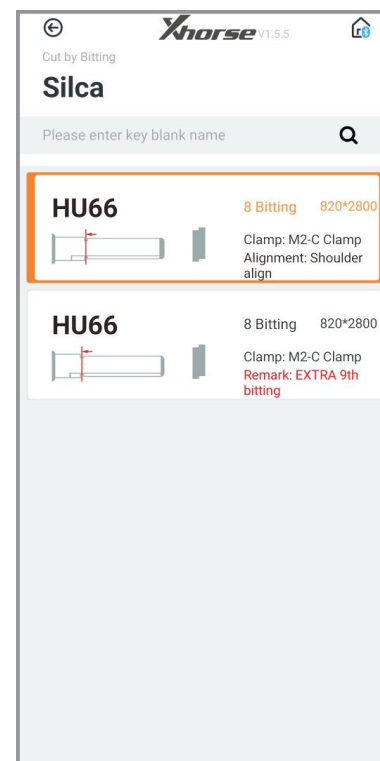

3) Select the key type.

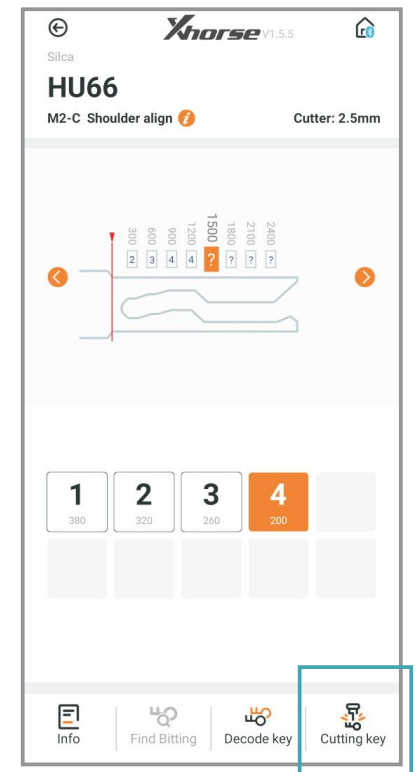

4) Fix the key according to the picture show, select proper side of clamp and fix the key in correct position. Put in the key bitting and check all the information before you click on 'Cutting key' for make new key.

Method 2 :  
Making a key with the original key.



1) Click on 'Cut by Bitting' and select a key blank type.

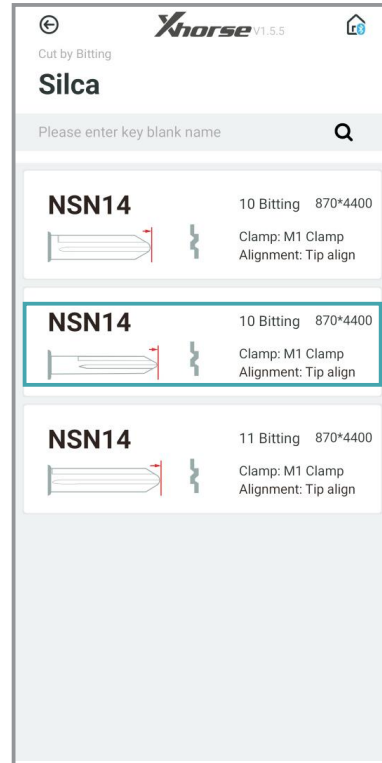

2) Select the key type.

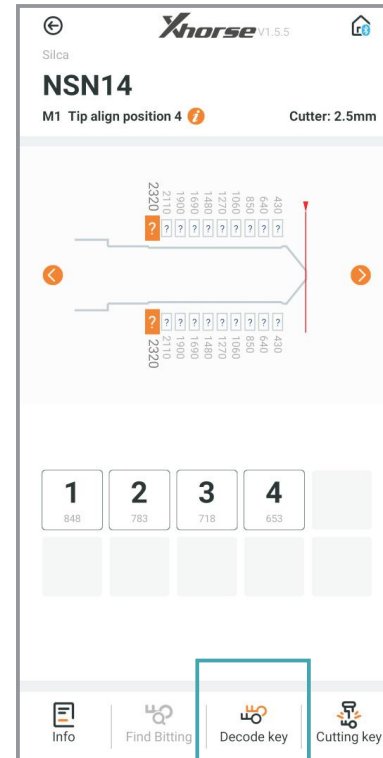

3) Click on 'Decode Key' to duplicate key bitting.

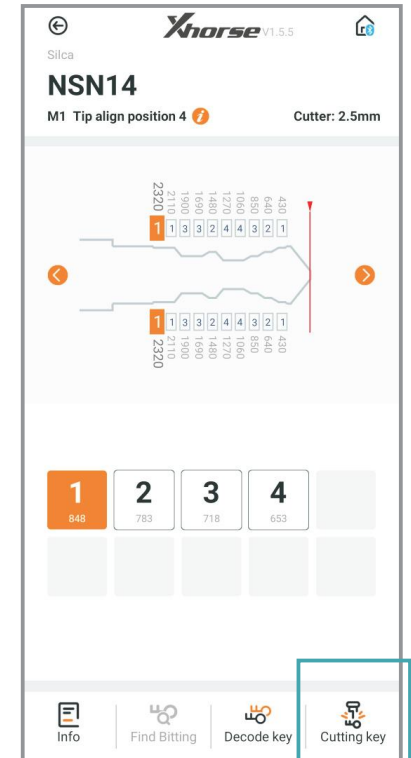

4) Click 'Cutting Key'.

## 6.7 How to use find bitting

Parts of the cars are missing bitting on door lock/trunk lock if compene with ignition lock. Users can find out the unknown bitting and replace the unknown bitting as"?"

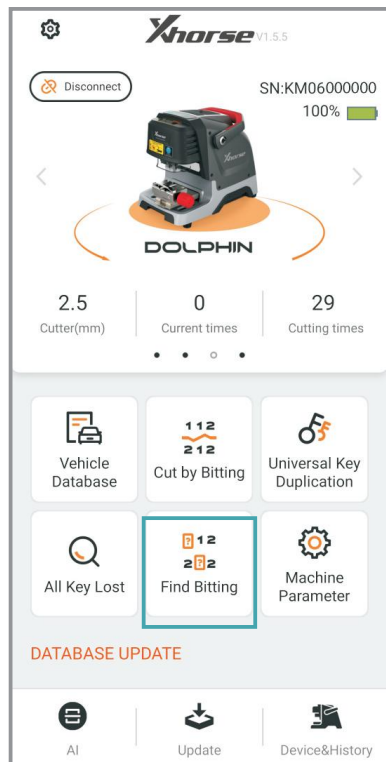

1) Click on 'Finding Bitting'.

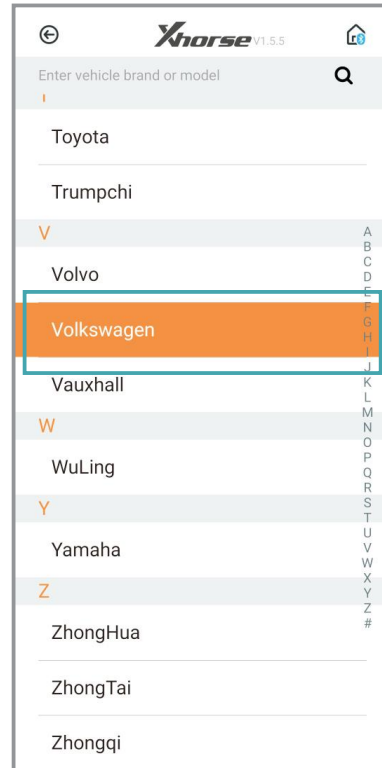

2) Select a car maker.

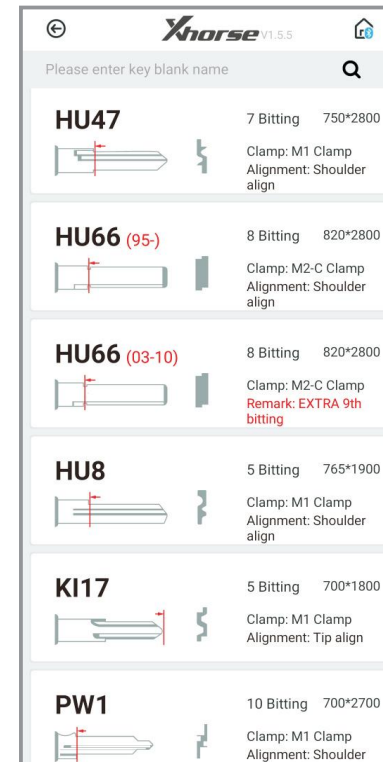

3) Select or put in the key blank type.

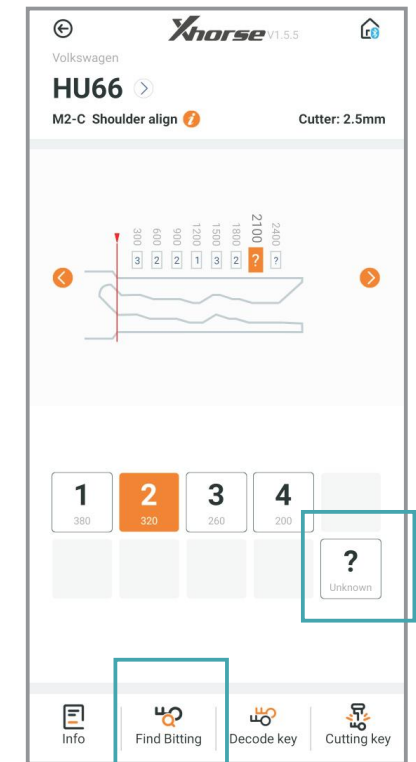

4) Put in the known bitting and replace unknown bitting as"?". Then click on 'Find Bitting'.

## 7. Online update

### 7.1 Database online update

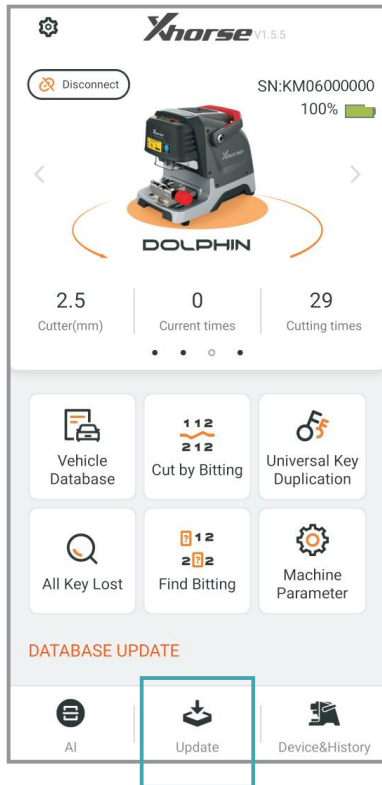

1) Enter Dolphin XP-005 main interface and click 'Update'.

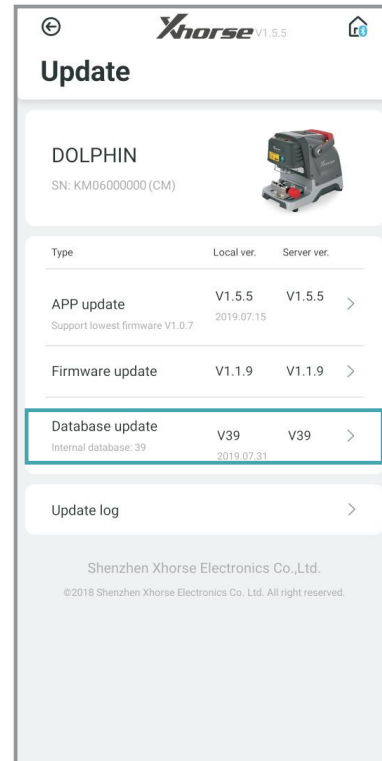

2) Click 'Database update'.

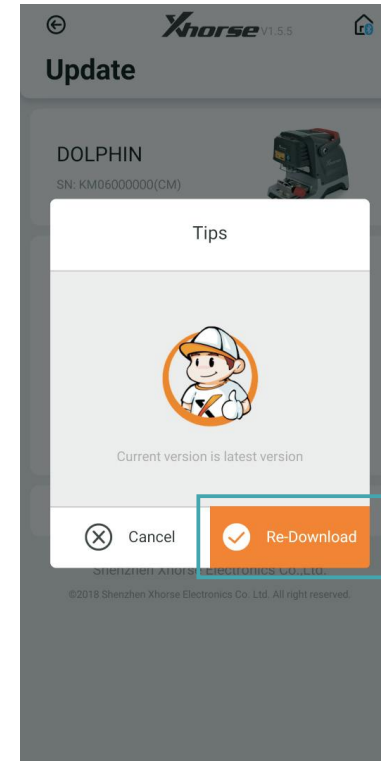

3) If you find a new version, click 'Update' and download the new version. Click on 'OK' after download database success.

\* If cellphone connected by mobile Internet data, a prompt saying that download maybe costs data fee, recommended downloading by WiFi.

## 7.2 Update by upgrade kit

Three ways to get the update package:

1. Contact your distributor and ask for 'Upgrade Kit'
2. Send an email titled 'update tool' to [support@xhorse.com](mailto:support@xhorse.com)
3. Consult with online customer service on Xhorse App.

Steps to update both database and firmware with update package:

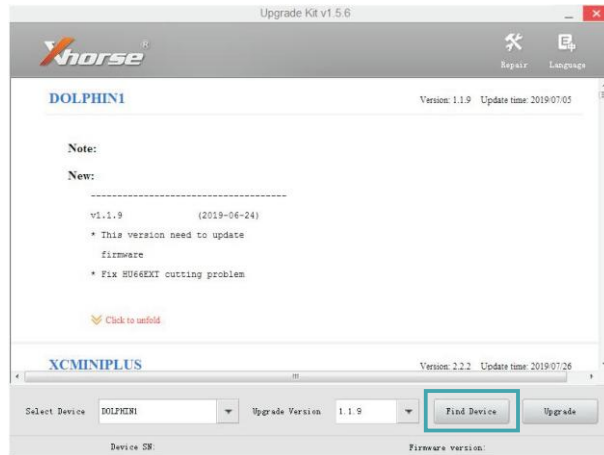

- 1) Connect the dolphin with a computer through USB cable, run 'Upgrade Kit', and click 'Find Device'.

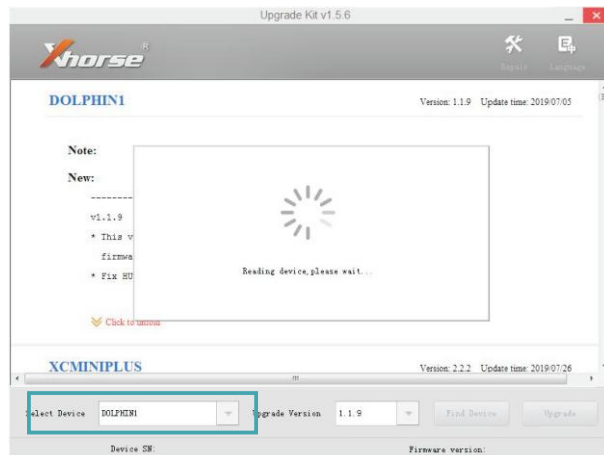

- 2) The connected device will be recognized and shown on left corner.

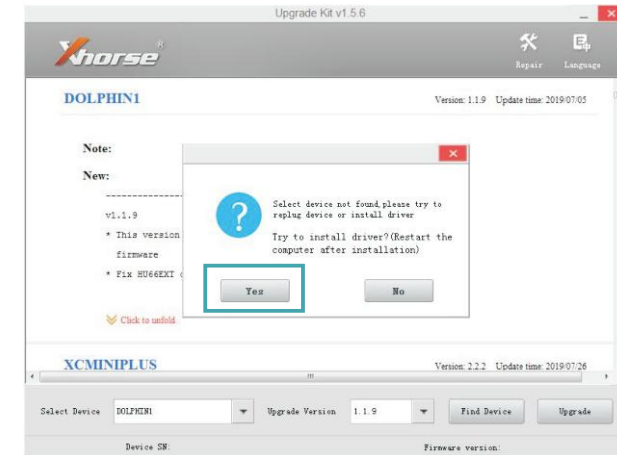

- 3) If the device cannot be found, follow the tips on screen and click 'Yes' to install driver.

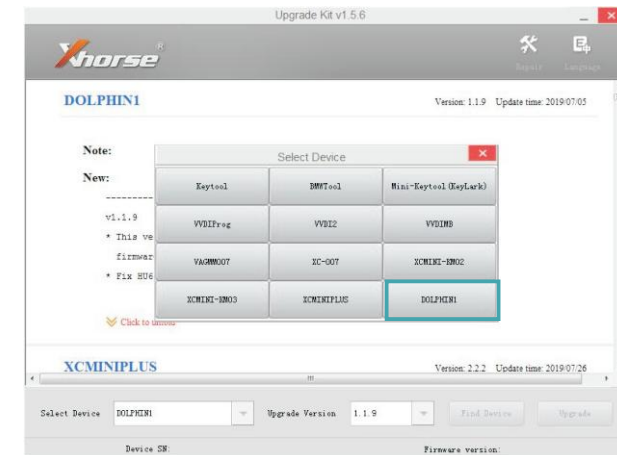

- 4) Select DOLPHIN1 and install driver.

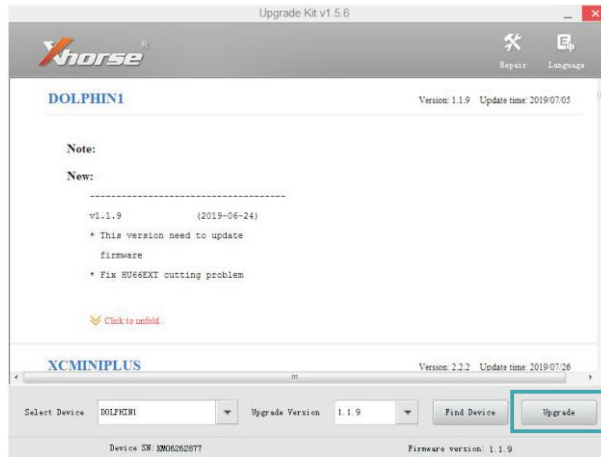

5) When the dolphin machine is found, click 'Upgrade'.



6) It takes a few minutes to complete upgrading. Please make sure the USB cable is always well connected when upgrading.

## 8. Maintenance

- Please clean the area around clamps with a brush before the machine starts to work. This is to assure cutting precision and avoid components damage by metal particles.
- To avoid damage or corrosion to the machine, please do not use detergent or other cleaning products to clean the machine.
- Please do not flush or wet the machine with water, in case rust and electrical current leakage.
- Under any circumstance, please do not try to clean the working area with air guns and drying machines, in case any metal carvings getting inside the machine.

## 9. Warranty and after-sale description

DOLPHIN XP-005 has a warranty of 1 year for machine and six months for battery. The warranty starts from the date on invoice. If there is no invoice or the invoice is missing, purchase records from factory is used as reference.

Within Warranty, free maintenance and repairing is not provided if the machine becomes dysfunctional due to the following reasons:

- Operation without referring to or violating the user manual
- Modifications or repairs to the machine by individuals
- Falling, knocking or wrong voltage
- Force majeure
- Use of the machine in places such as ships that are bad for the machine for a long time
- Damaged or worn-out plastic case and protective shield due to frequent use

Regarding to customer service and technical support, please contact distributors or Xhorse online customer service team by scanning the QR code below and downloading Xhorse official App.



Xhorse APP

All the information and illustrations in this document are for guidance only. Xhorse reserves the right to alter products designs, dimensions or info to improve the products quality. The contents of this document are fully protected by Copyright and may not be copied or reproduced in any form (e.g. mechanical, electronic, printing or video recording), without permission from Xhorse.